

2023

Product Guide

 **Arozzi**
KEEP YOURSELF IN THE GAME!

PRIMO Woven Fabric™



PRIMO Full Premium Leather



Rocking Function

Lumbar Cushion

Built-in

5 Locking Tilt Positions

150° Recline angle

Locking Recline every 5°

Velour Neck Pillow

Premium Leather

Ergonomic

NAPA

BIFMA CERTIFIED BIFMA

4D

4-Dimensional Armrests

Height Adjustment

Sturdy Aluminum 5-star base

145kg (320lbs) Capacity

Reinforced Metal Frame



PRIMO PU

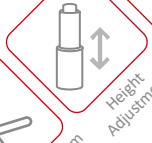
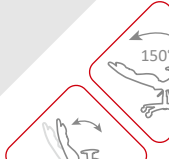
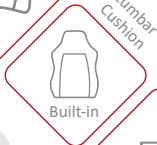

VERNAZZA SuperSoft™



VERNAZZA Vento™



Ergonomic



SOFT FABRIC™



VENTO PU™

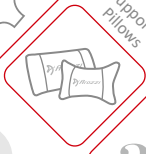

2 Supportive Pillows

3-Dimensional Armrests



5 Locking Tilt Positions

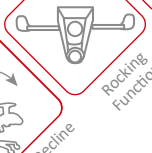

Rocking Function

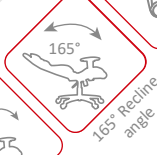

165° Recline angle



165° Recline every 5°



Height Adjustment



Large Wheels



145kg (320lbs) Capacity



Sturdy Metal Frame



VERNAZZA Soft Fabric™



VERNAZZA

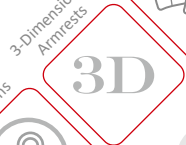

VERONA Signature Soft Fabric™



Ergonomic



Durable Upholstery 2-Supportive Furniture Fabric



2-Supportive Pillows



4-Dimensional Armrests



4D



5 Locking Tilt Positions



Rocking Function



Locking Recline every 5°



165° Recline angle



Sturdy Metal Frame

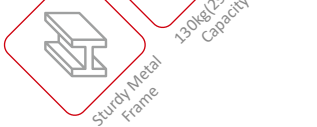

130 kg (290 lbs) Capacity



Height Adjustment



VERONA Signature PU



- 5 Locking Tilt Positions
- 4-Dimensional Armrests
- 4D
- 2 Supportive Pillows
- PU Leather
- Ergonomic
- Rocking Function
- 165° Recline angle
- Locking Recline every 5°



- Height Adjustment
- 130kg (290lbs) Capacity
- Sturdy Metal Frame



VERONA XL+



- Rocking Function
- 2 Supportive Pillows
- PU Leather
- Ergonomic
- 5 Locking Tilt Positions
- 165° Recline angle
- Locking Recline every 5°

1D

Height Adjustable Armrests



Height Adjustment



Sturdy Aluminum 5-star base



160 kg Capacity



Reinforced Metal Frame



VERONA PRO V2



1D
Height Adjustable Armrests

130 kg
Capacity

Sturdy Metal Frame

VERONA V2



- Rocking Function
- 2 Supportive Pillows
- PU Leather
- Ergonomic
- 165° Recline angle
- Locking Recline every 5°
- Height Adjustment



- 1D Height Adjustable Armrests
- 105kg (231lbs) Capacity
- Sturdy Metal Frame



VERONA JUNIOR



Ergonomic



Child Size



Easy Clean
PU Leather



2 Supportive
Pillows



Rocking
Function



165°
Recline
angle



Locking Recline
every 5°



Height
Adjustment



2-Dimensional
Armrests



60kg (132lbs)
Capacity



Sturdy Metal
Frame



MEZZO/FORTE PU



- 2 Supportive Pillows
- Molded Foam
- PU Leather
- Ergonomic
- Locking Recline every 5°
- Rocking Function
- 165° Recline angle
- Height Adjustment



- 1D Height Adjustable Armrests
- 120kg (265lbs) Capacity
- Sturdy Metal Frame



MEZZO/FORTE Fabric

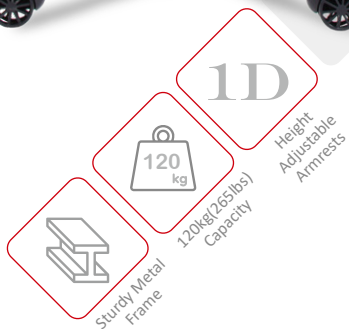

TORRETTA



ONLY AVAILABLE IN EU



2D

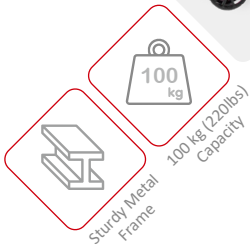

100 kg

100 kg (220lbs) Capacity



TORRETTA Soft Fabric™

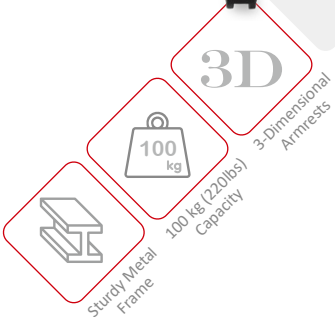

INIZIO



INIZIO PU Leather



Locking Recline every 5°

Rocking Function

2 Supportive Pillows

PU Leather

Ergonomic

145° Recline angle

Height Adjustment

Height adjustable armrest

1D



105kg (231lbs) Capacity

Sturdy Metal Frame



ENZO



ONLY AVAILABLE IN EU



- Rocking Function
- PU Leather
- Height Adjustment
- Extra Padded Armrests
- 95kg (210lbs) Capacity
- Wood Frame





ENZO Woven Fabric™



- Woven Fabric
- Rocking Function
- Height Adjustment
- Extra Padded Armrests
- 95kg (210lbs) Capacity
- Wood Frame



MONZA



ONLY AVAILABLE IN EU



- Rocking Function
- PU Leather
- Height Adjustment
- Extra Padded Armrests
- 95kg (210lbs) Capacity
- Wood Frame



MILANO



ARENA



160cm (5'3") x 82cm (2'8.25")
160cm
82cm
10cm
10cm (4in) Height Adjustment

Cable Management
 Microfiber
 Machine Washable
 Fluid Resistant
 Full Surface Edge-Stitched Desk Mat
 Monitor Mount Cutouts
 Cable Management Pouch Underneath
 Steel Legs & MDF Surface





ARENA DESKPAD

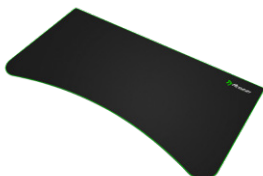
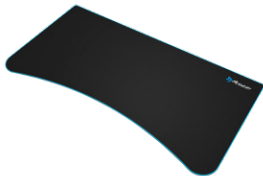
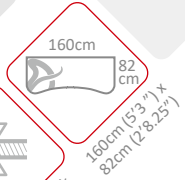

ARENA FRATELLO



Cable Management
114cm (3'9") x 72cm (2'4.3")
Microfiber
Machine Washable
Fluid Resistant
Full Surface Edge-Stitched Desk Mat

114cm
72cm

Monitor Mount Cutsouts
Cable Management Pouch Underneath
Steel Legs & MDF Surface





ARENA FRATELLO DESKPAD

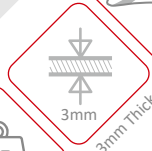
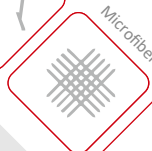

114cm(3'9") x 72cm(2'4.3")

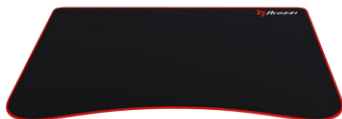

ARENA LEGGERO



114cm(39") x 72cm(24.3")

114cm 72cm

- Full Surface Edge Stitched Desk Mat
- Fluid Resistant
- Machine Washable
- Microfiber
- Cable Management
- Monitor Grommet Mount Cutouts
- Cable Management Pouch Underneath
- 80kg(176lbs) Capacity
- Steel Legs & MDF Surface

PATENTED
EP 3485765 B1
PATENTED





ARENA LEGGERO MOUSE PAD



Custom Leggero Desk fit

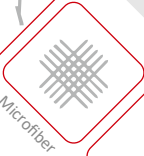

Microfiber



Fluid Resistant

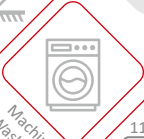

Machine Washable

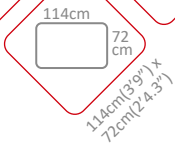

114cm

72cm

114cm(39.1") x 72cm(24.3")



3mm Thick



Interchangeable



Anti-Slip Rubber bottom



2.5 kg

2.5kg(5.5 lbs)



ARENA MOTO



- Electrical Lift
- Full Surface Edge Stitched Desk Mat
- Fluid Resistant
- Machine Washable
- Microfiber
- 160cm x 82cm (5'3" x 28.25")
- Cable Management
- Monitor Mount Cutouts
- Height Adjustment
- Cable Management Pouch Underneath
- Steel Legs & MDF Surface
- 120kg (264lbs) Capacity



ZONA MOUSE PADS

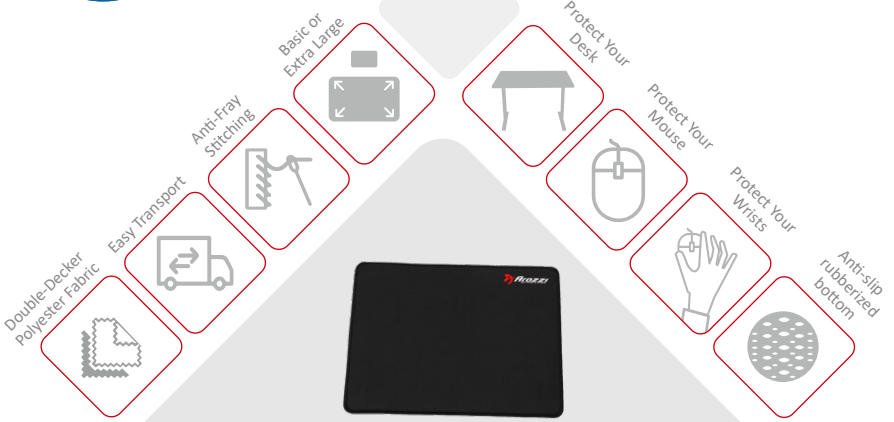

VELOCITÀ



Attach To Your Existing Chair



Compactible For Easy Storage & Mobility



Sturdy Steel



Compatible With Most Popular Racing Simulators



Able to Attach Wheel, Pedals, & Gear Shifting Box





VELOCITÀ MAT



Custom Made to Fit Velocità Dimensions

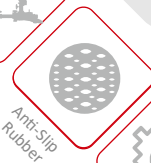

Anti-Slip Rubber



Protective Cloth on Top



Prevents Scratches to Floor Surfaces

120cm
60cm

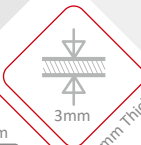

3mm
3mm Thick

120x60cm
(47.2x23.6in)



*Mat & Velocità Sold Separately

ARIA



COLONNA



SFERA PRO





SFERA



- Cardioid Pickup Pattern
- Headphone Jack
- Volume Control
- Mute Function
- Boom Arm Thread Mount
- Plug & Play
- USB Plug-in



OCCHIO True Privacy™ Webcam



True Privacy™
Dual Omni-Directional
Noise Cancelling
Microphones

Two red-bordered icons: a shield with a padlock and a microphone.

Full HD 1080p
@ 30FPS

A red-bordered icon showing a film strip with a camera lens in the center.

Autofocus
Glass Lens

A red-bordered icon showing a camera lens with a focus ring.

Various
Mounting
Options

A red-bordered icon showing a desk-mounted webcam on a stand.

OCCHIO RL True Privacy™ Webcam



True Privacy™

LED Ring Light
3 Color Temperature



Adjustable
Brightness



Dual Omni-Directional
Noise Cancelling
Microphones



Full HD 1080p
@ 30FPS

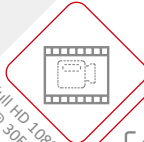

Autofocus
Glass Lens



Various
Mounting
Options



Requires
2 x USB 2.0 Ports
/ 1 x USB 3.0 Port





- Monitor Size**
13"-27"
- Weight Capacity**
1,5-7Kg
- Screen Rotation**
360°
- Tilt**
-70° ~ +60°
- Swiveling**
180°
- VESA**
75x75 / 100x100
- Clamp Type**
 - Grommet
 - C-clamp



ALZARE DUO

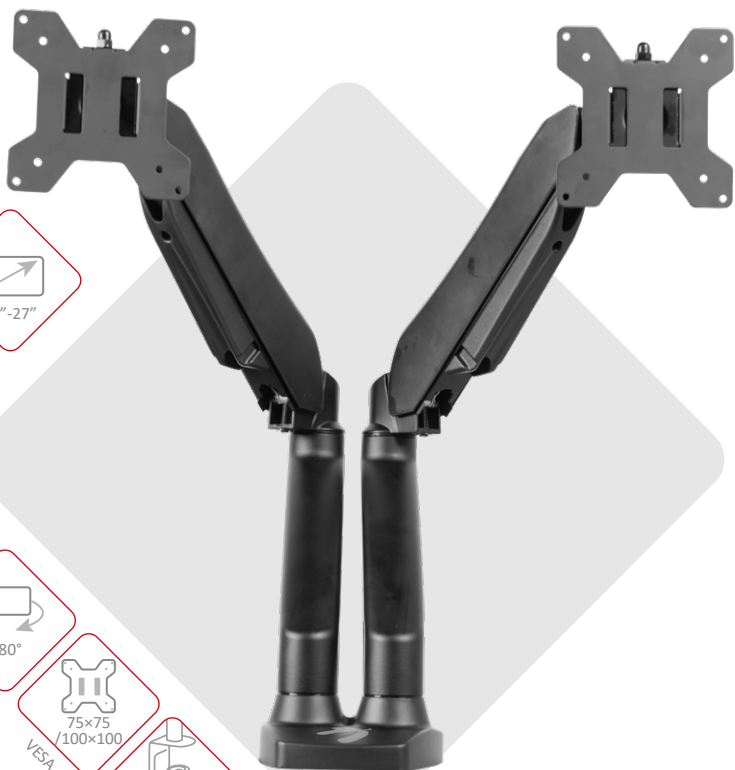

- Screen Rotation: 360°
- Tilt: -70° ~ +60°
- Swiveling: 180°
- VESA: 75x75 / 100x100
- Clamp Type: C-clamp
- Clamp Type: Grommet
- Weight Capacity: 1,5-7Kg
- Monitor Size: 13"-27"

VISIONE



GREEN SCREEN

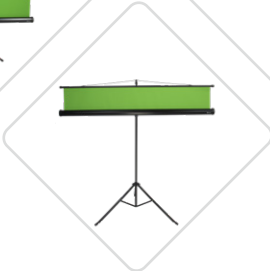
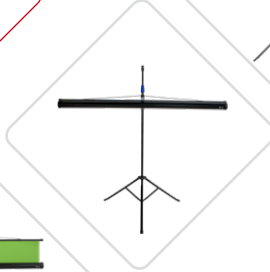
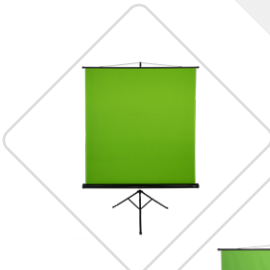
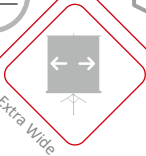
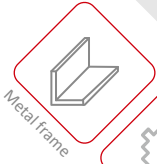

FAVO ULTRA LIGHT



-  Pixart® 3389 Sensor
-  Extremely light weight
-  Ultra-flexible Cable
-  7 buttons
-  Omron Omron 20M Omron switches
-  RGB bottom panel
-  Adjustable 200~16000 Dpi
-  74g Extremely light weight 74 gram



FAVO 2 ULTRA LIGHT



- 7 buttons
- Ultra flexible Cable
- Extremely light weight
- Pixart® 3389 Sensor
- Omron switches
- RGB bottom panel
- Adjustable
- Extremely light weight 74 gram



Cleaning Kit





ANCORA Mouse Cable Holder



- Rubber feet
- Extendable Spring
- Secure Cord Holder
- Portable
- Weighted for Stability



FLOOR MAT



Soft velvety material



Noise dampening of chair movement

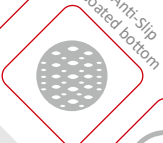

Anti-Slip coated bottom



Protects your floor from scratches



ZONA FLOOR PAD



Simplistic Design

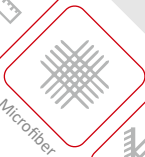

Microfiber



Noise Dampening

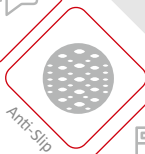

Anti-Slip



Easy to Clean



Protects your floor from scratches



Memory Foam Armrest Pads





LUMBAR SUPPORT



-  Ergonomic
-  Memory Foam
-  Velour
Cover Material
-  Easy to clean
-  Back Straps
-  Universal
and Portable

FOOTREST - Soft Fabric™





Contact Us

Arozzi

Transformatorgatan 9
595 35
Mjölby, Sweden

WWW.AROZZI.EU



Sales Contact:

- ◆ **Europe**
Lars Pettersson
lars@arozzi.com
- ◆ **North America**
Brian Hutchins
brianh@arozzi.com
- ◆ **South America**
Lars Pettersson
lars@arozzi.com
- ◆ **Middle East**
Mathias Lofholm
mathias@arozzi.com
- ◆ **Asia**
William Andersson
william@arozzi.com