

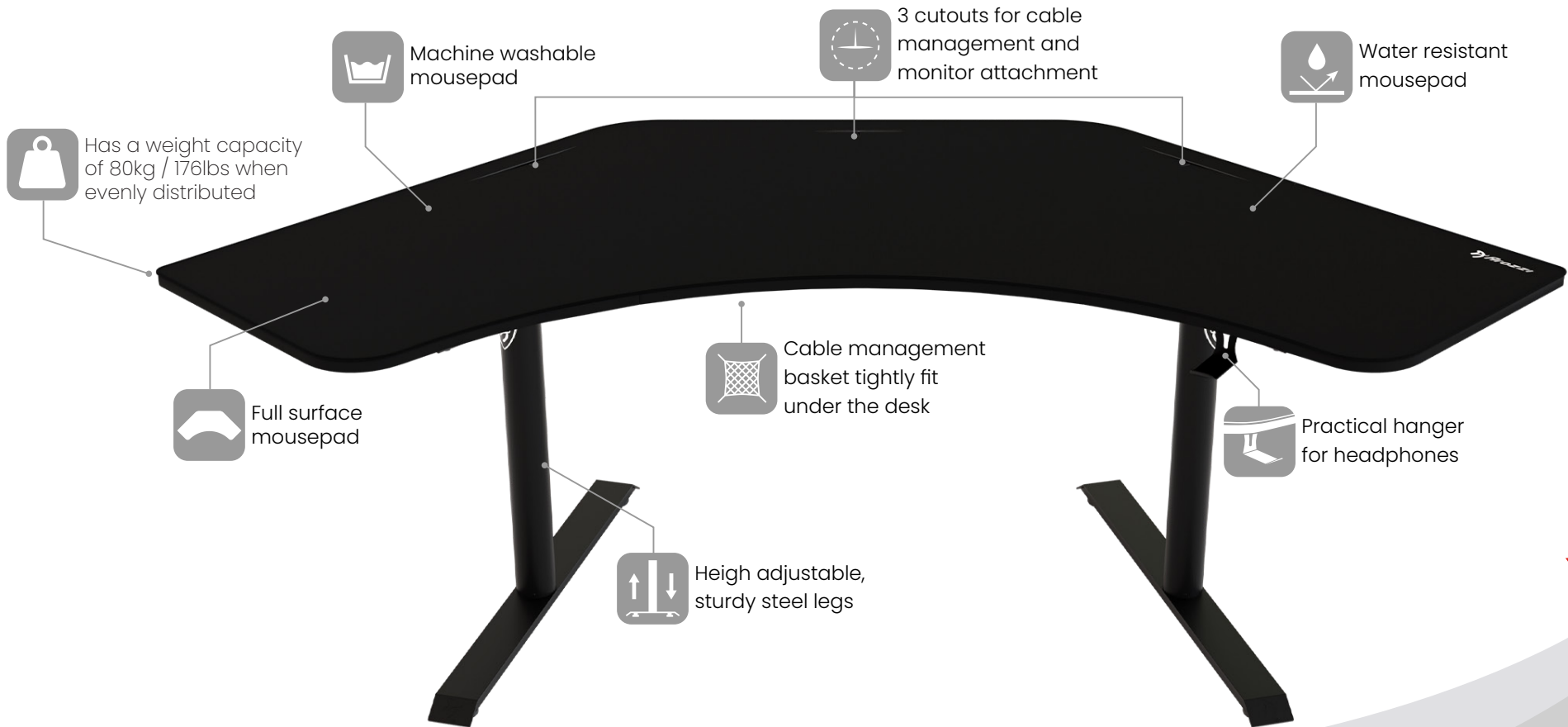

# ARENA ANGELO

Built for comfort and endurance, the Arena Angelo features a spacious, ergonomic design ideal for multiple monitors, peripherals, and all your gaming essentials. As a corner desk, it provides various advantages from a furnishing standpoint, including efficient use of space, enhanced accessibility, and aesthetic appeal. The entire surface of the desk is covered with a liquid repellent, microfiber mousepad. The desk features three strategically positioned cutouts, used for attaching your monitors or guiding cables neatly to a mesh basket snugly secured beneath the desk.



# Colors



Pure Black

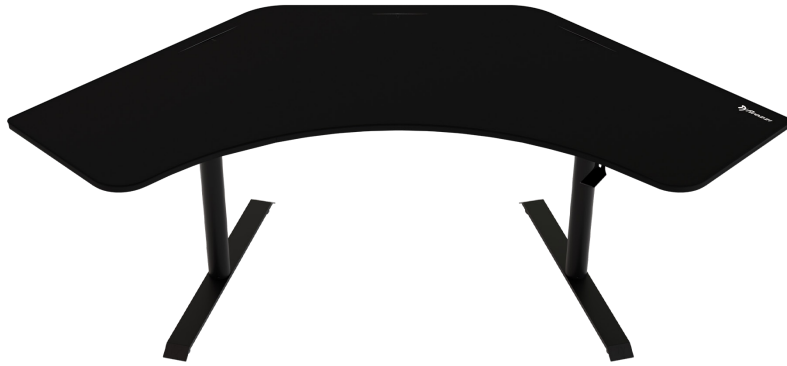

Crawling Chaos



Black

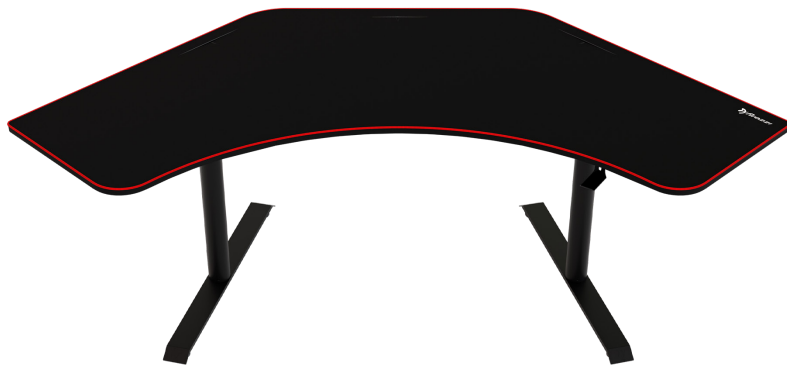

Gun Metal



# Combinations

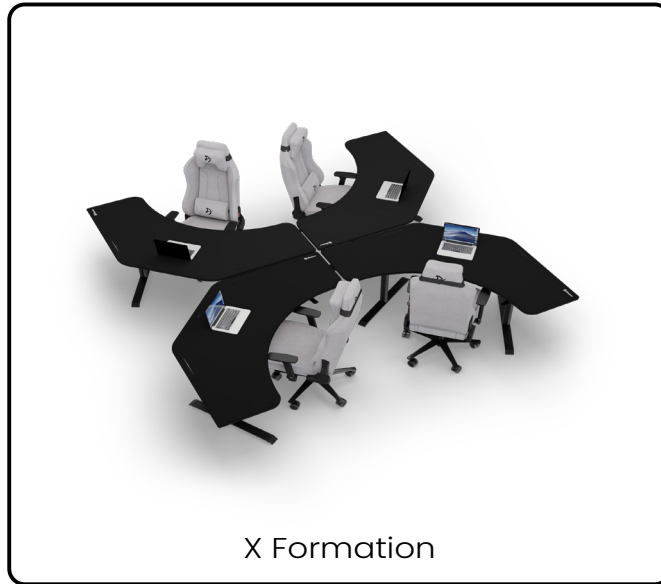

X Formation

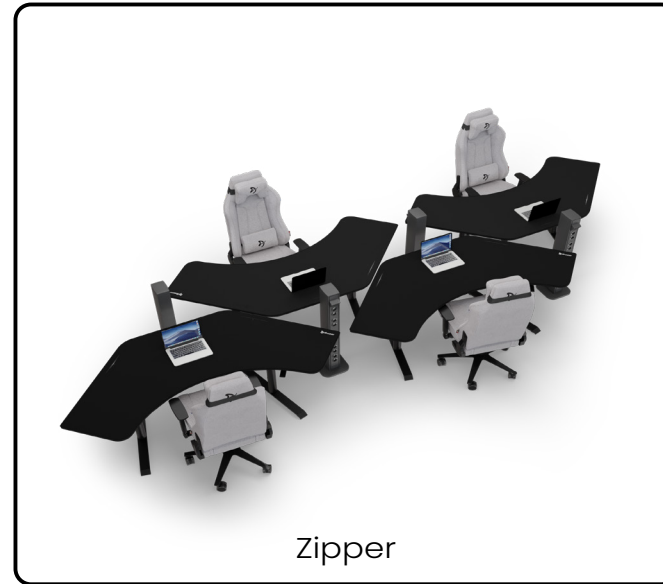

Zipper

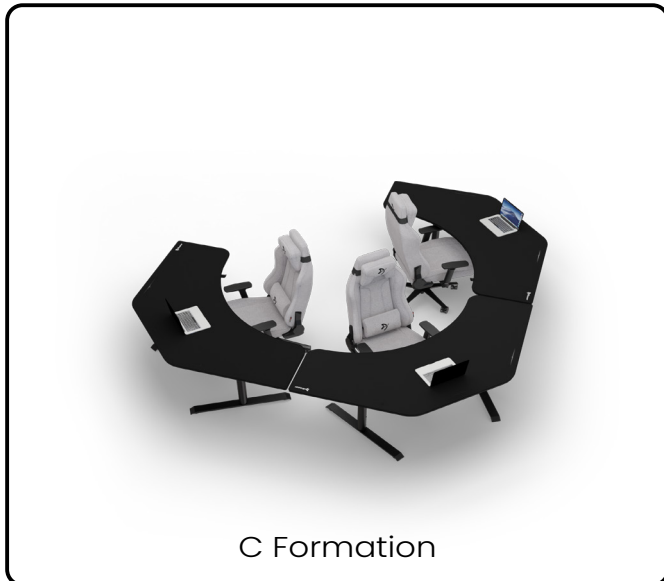

C Formation

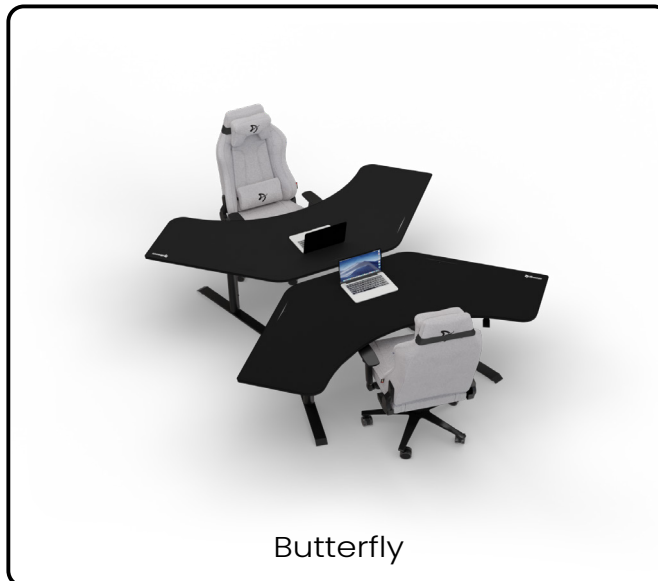

Butterfly



Star

# Logistics & Specs



## Master SKU/UPC

- ARENA-ANGELO-BK-M.....850054766120
- ARENA-ANGELO-PBK-M.....850054766137
- ARENA-ANGELO-GM-M.....850054766144
- ARENA-ANGELO-CHAOS-M.....850054766113

## Box 1 SKU/UPC

- ARENA-ANGELO-BK.....850054766083
- ARENA-ANGELO-PBK.....850054766076
- ARENA-ANGELO-GM.....850054766069
- ARENA-ANGELO-CHAOS.....850054766090

## Box 2 SKU/UPC

- ARENA-ANGELO-BOX2.....850054766106
- ARENA-ANGELO-GM-BOX2.....850054766212

## Material

Frame.....Steel  
 Legs.....Steel  
 Feet.....Aluminium  
 Tabletop.....MDF Board  
 Mousepad.....Microfiber

## Box 1

**Net Weight**  
 24.9kg / 54.9 lbs

**Gross Weight**  
 30kg / 71.4 lbs

**Dimension**  
 103 x 53 x 35 cm  
 40.5 x 20.8 x 13.5 in.

## Box 2

**Net Weight**  
 21.8kg / 48.1 lbs

**Gross Weight**  
 25.2kg / 49 lbs

**Dimension**  
 108 x 77 x 10,5 cm  
 42.5 x 30 x 4.2 in.

## Container Quantity

Container 40 ft.....200 units

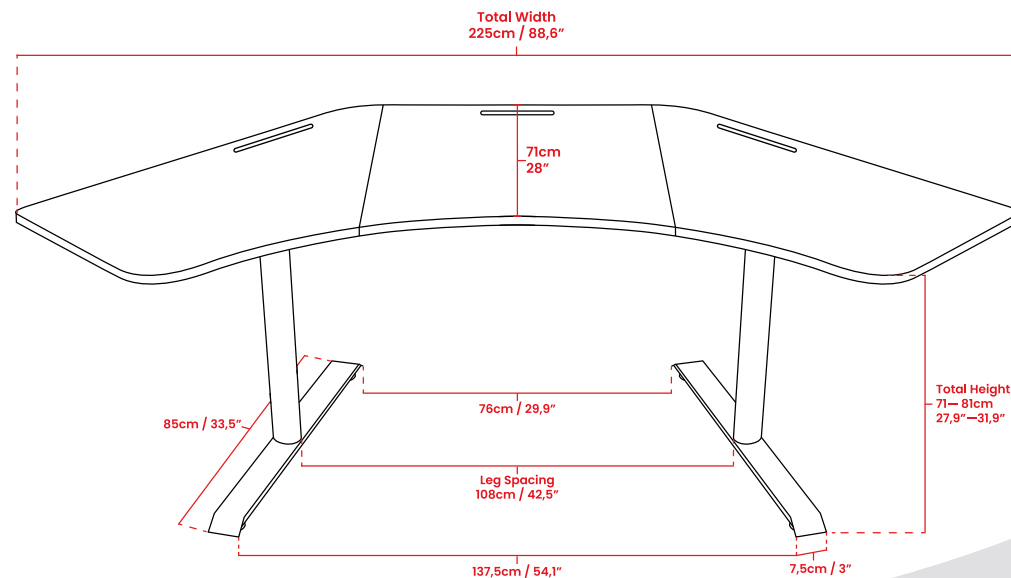
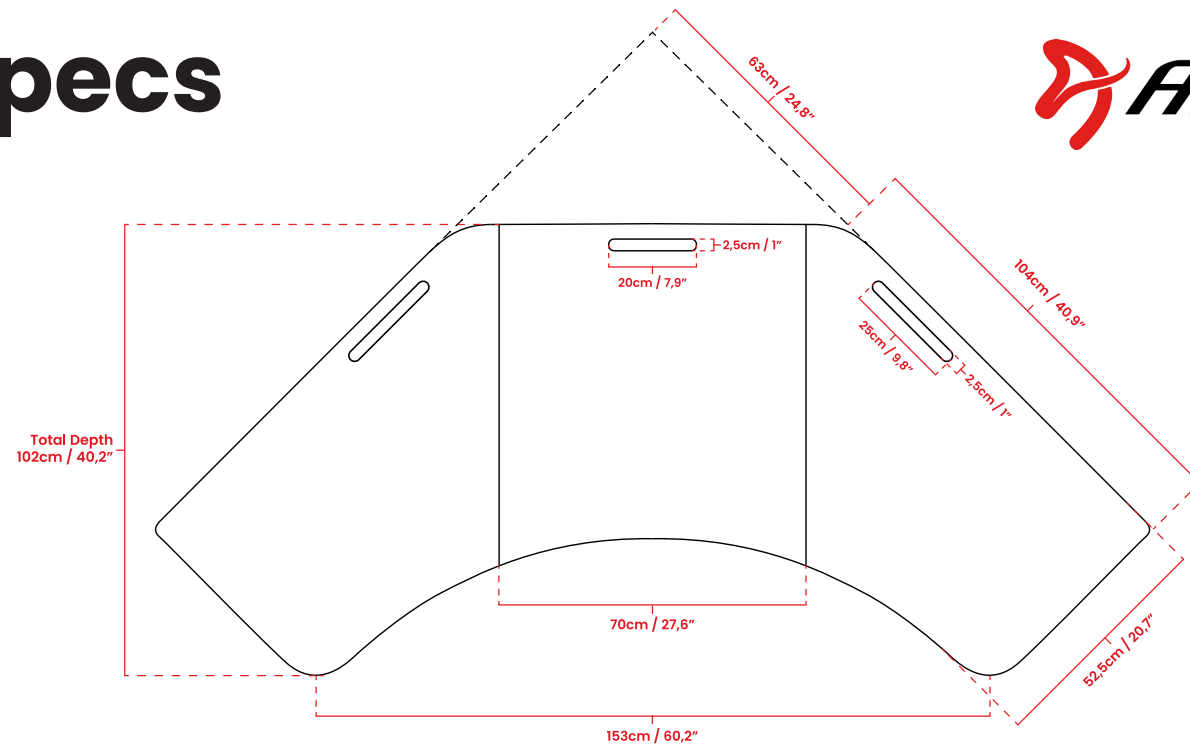

# Logistics & Specs



## Box 1 SKU/UPC

- ARENA-ANGELO-BK.....850054766083
- ARENA-ANGELO-PBK.....850054766076
- ARENA-ANGELO-GM.....850054766069
- ARENA-ANGELO-CHAOS.....850054766090

## Box 2 SKU/UPC

- ARENA-ANGELO-BOX2.....850054766106
- ARENA-ANGELO-GM-BOX2.....850054766212

## Material

Frame.....Steel  
 Legs.....Steel  
 Feet.....Aluminium  
 Tabletop.....MDF Board  
 Mousepad.....Microfiber

## Box 1

**Net Weight**  
 24.9kg / 54.9 lbs

**Gross Weight**  
 30kg / 71.4 lbs

**Dimension**  
 103 x 53 x 35 cm  
 40.5 x 20.8 x 13.5 in.

## Box 2

**Net Weight**  
 21.8kg / 48.1 lbs

**Gross Weight**  
 25.2kg / 49 lbs

**Dimension**  
 108 x 77 x 10,5 cm  
 42.5 x 30 x 4.2 in.

## Container Quantity

Container 40 ft.....200 units

