

# ARENA MOTO

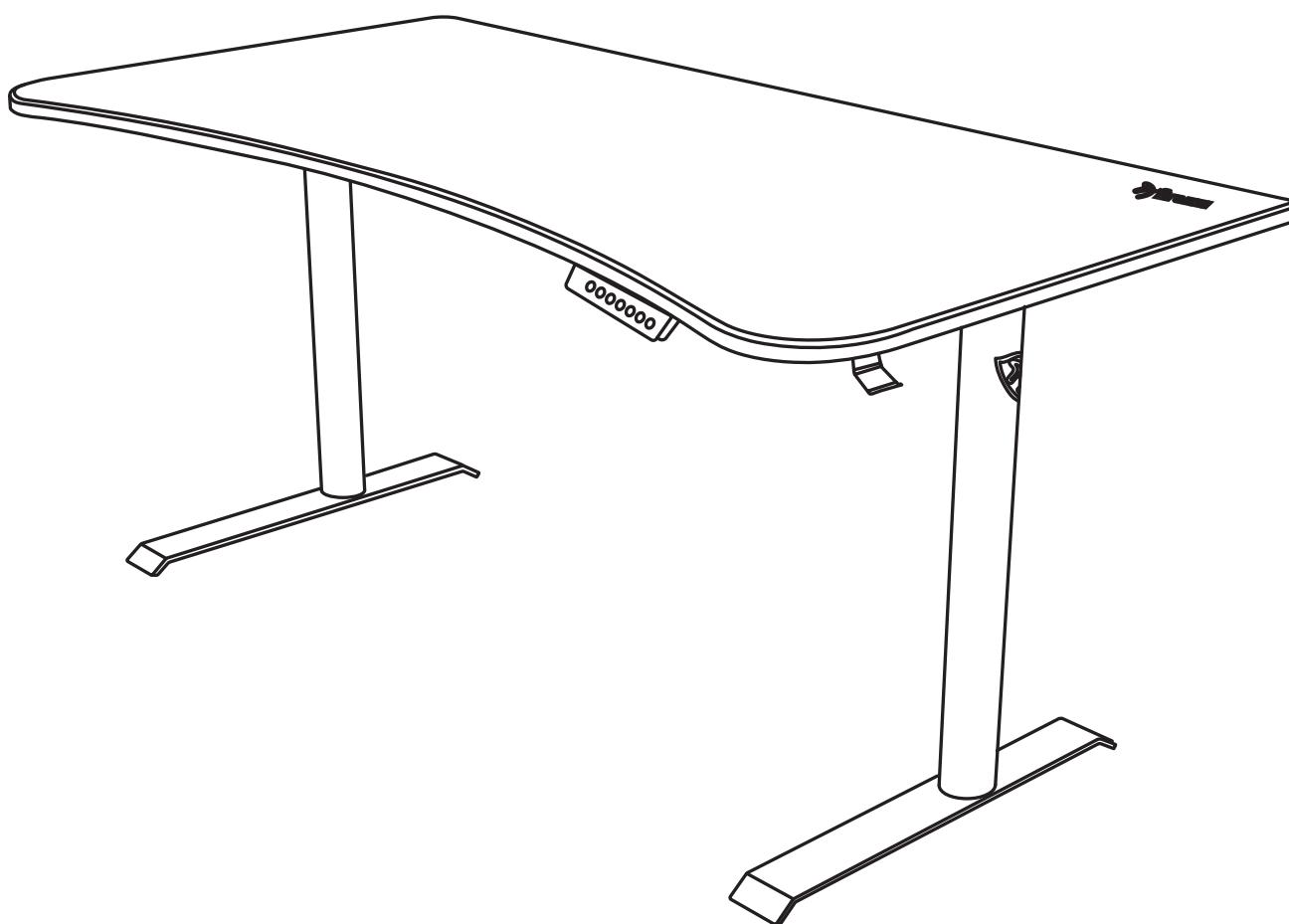

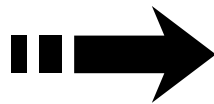

[youtube.com/@ArozziSupport](https://youtube.com/@ArozziSupport)

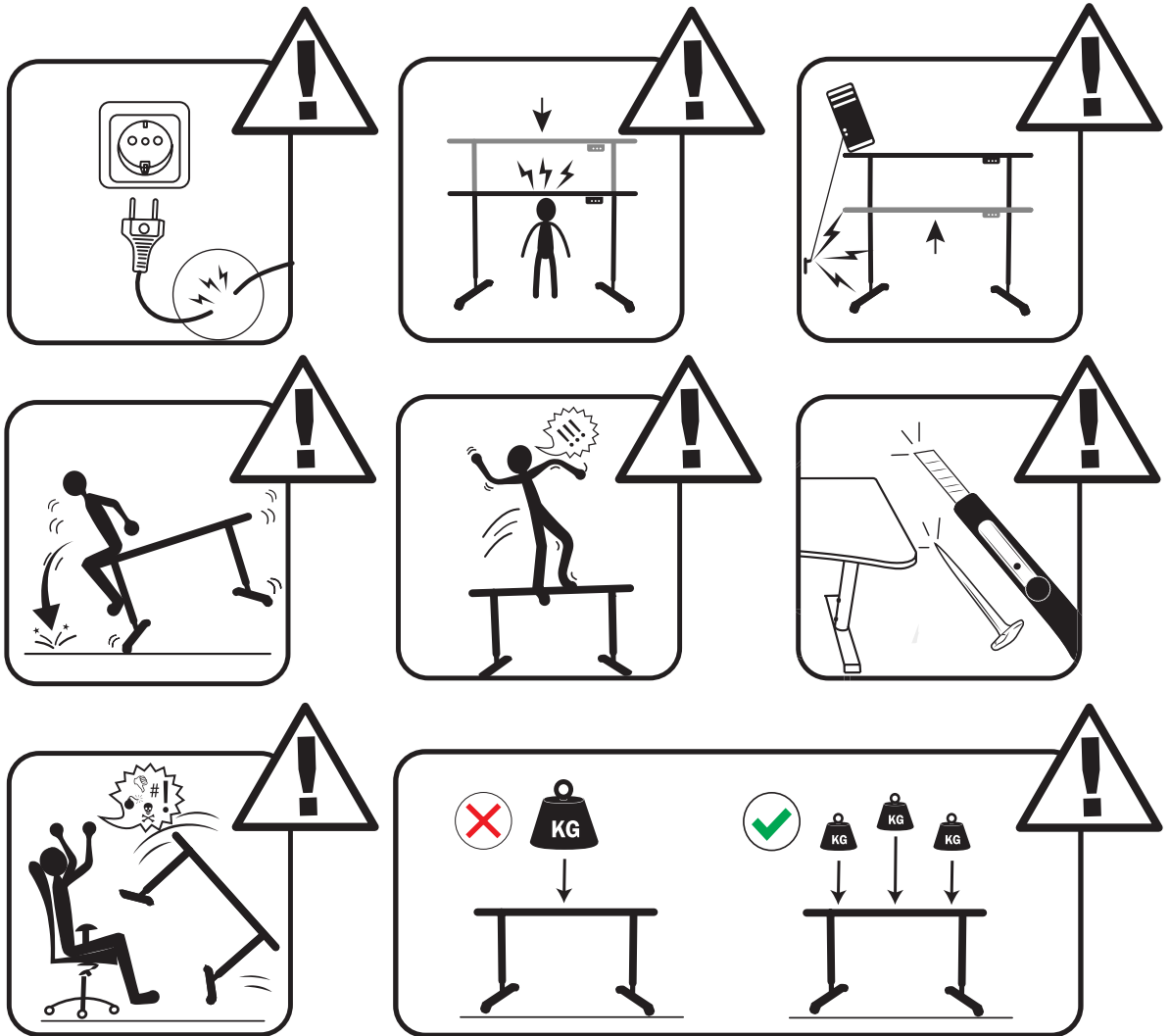

EU: [arozzi.se/support/](https://arozzi.se/support/)  
 US: [arozzi.com/support/](https://arozzi.com/support/)  
 Elsewhere: [arozzi.se/support/](https://arozzi.se/support/)

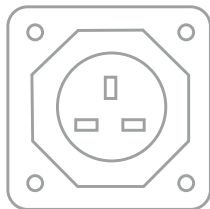
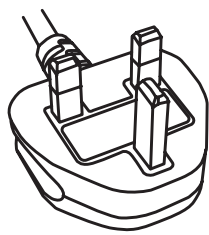
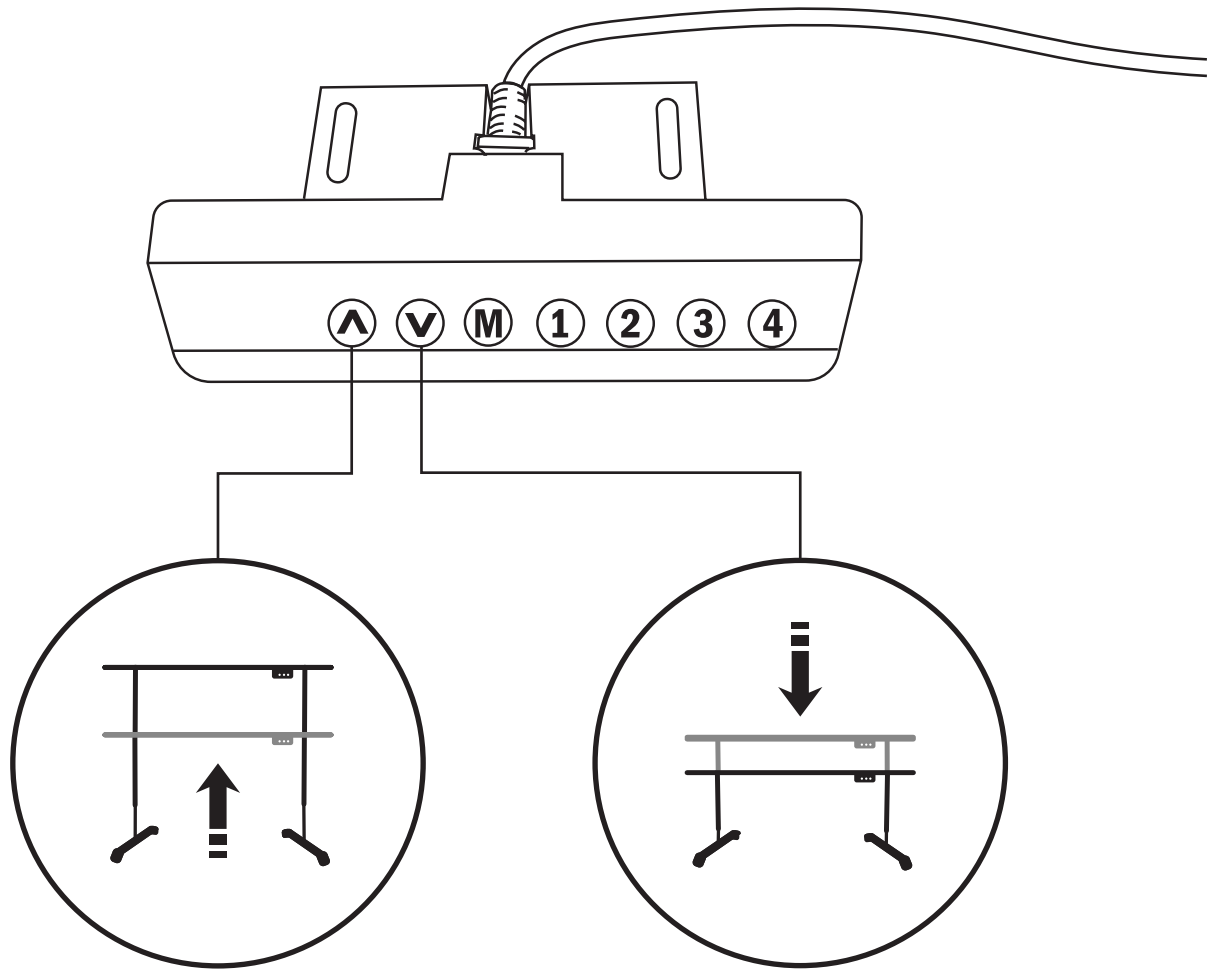

UK

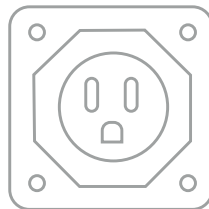
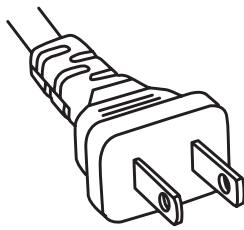

USA

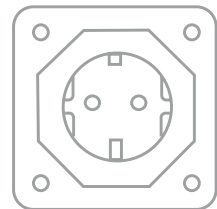
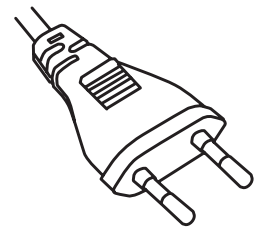

EU

**A**



x8

**B**

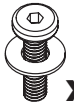

x16

**C**

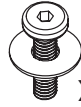

x8

**D**

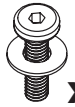

x14

**E**



x10

**F**

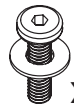

x12

**G**



x4

**H**



x2

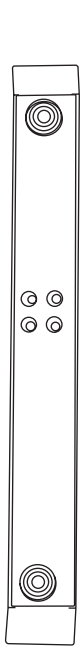

x2

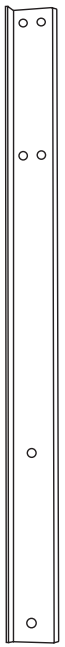

x2

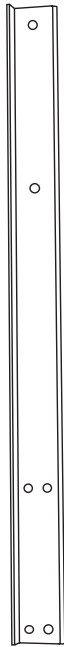

x2

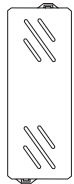

x1

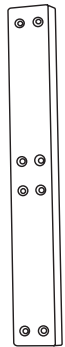

x2



x1

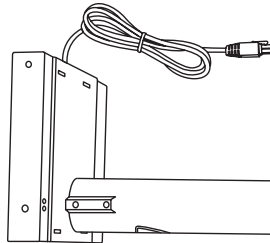

x1



x1

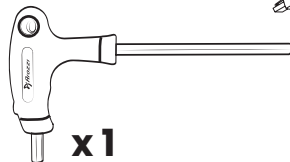

x1

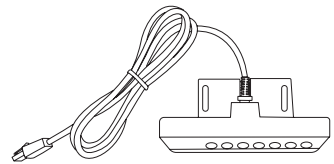

x1



x1

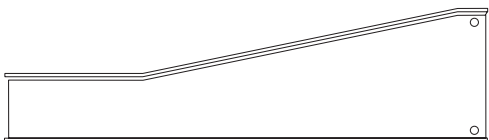

x1

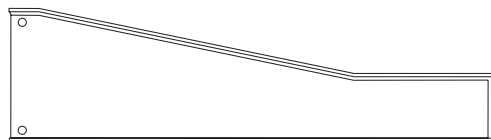

x1



x1



x1

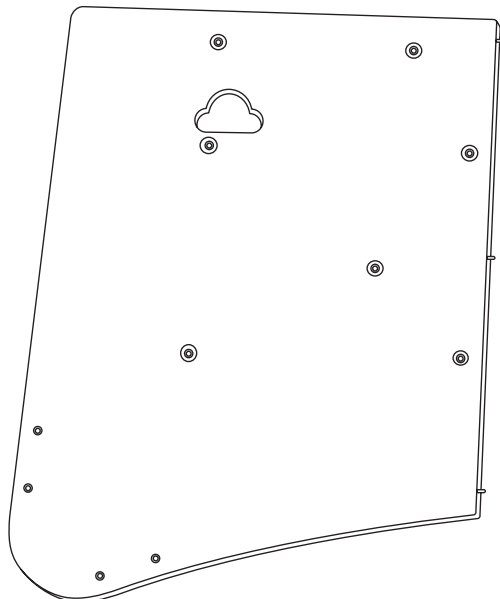

x1

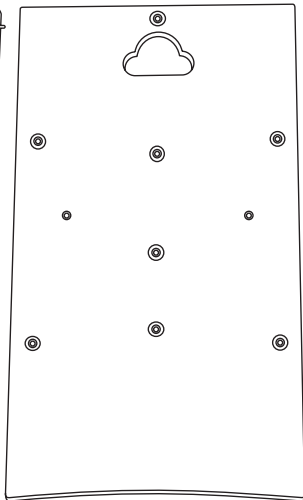

x1

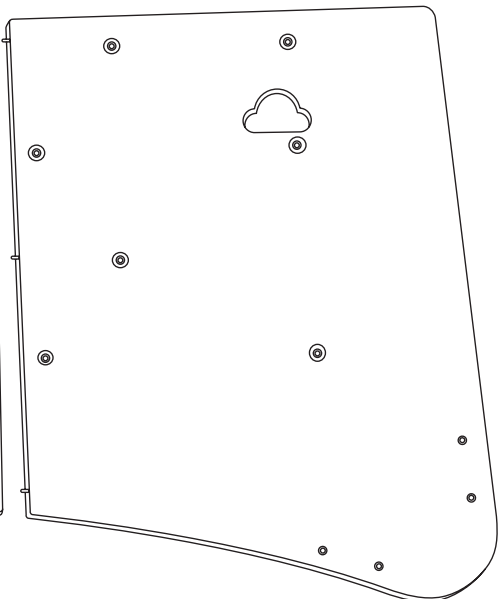

x1

1

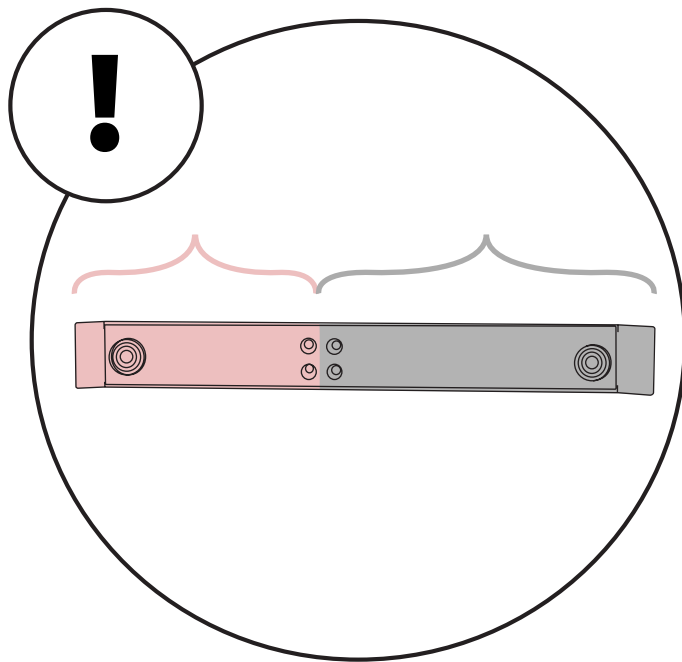
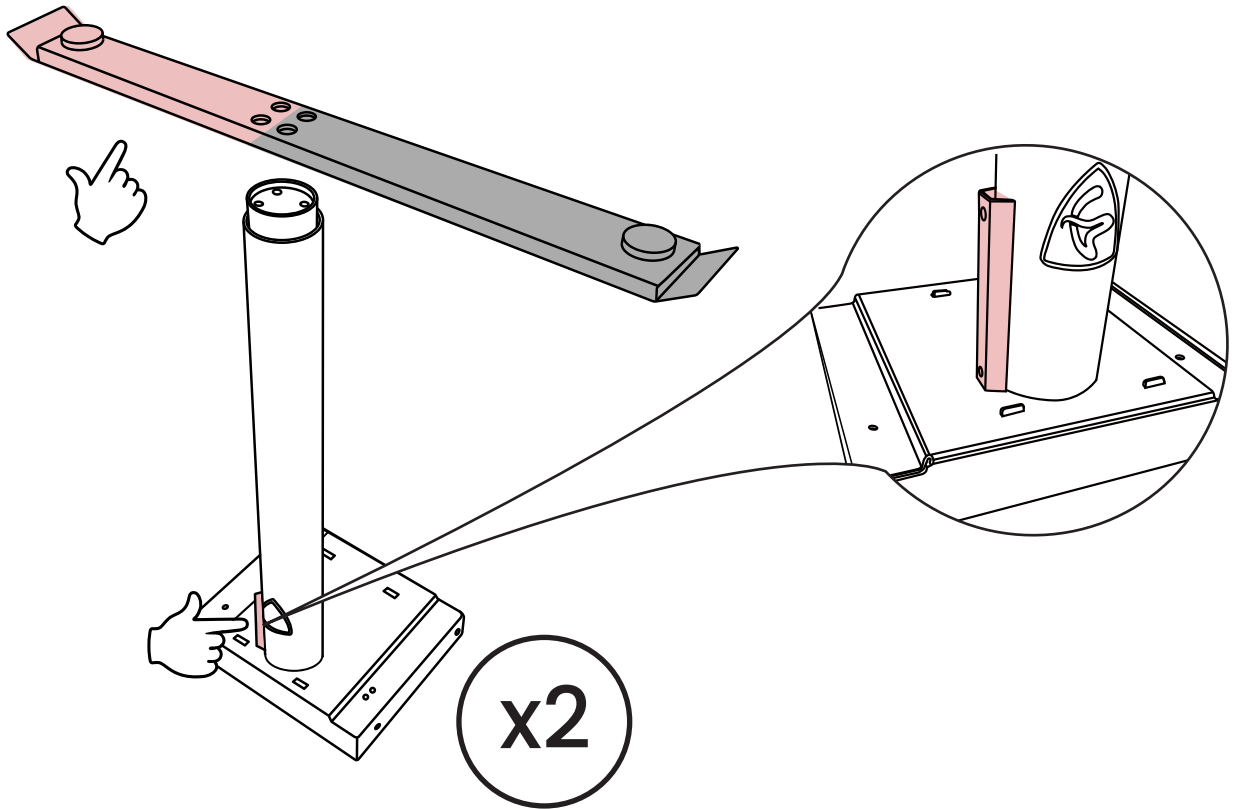

2

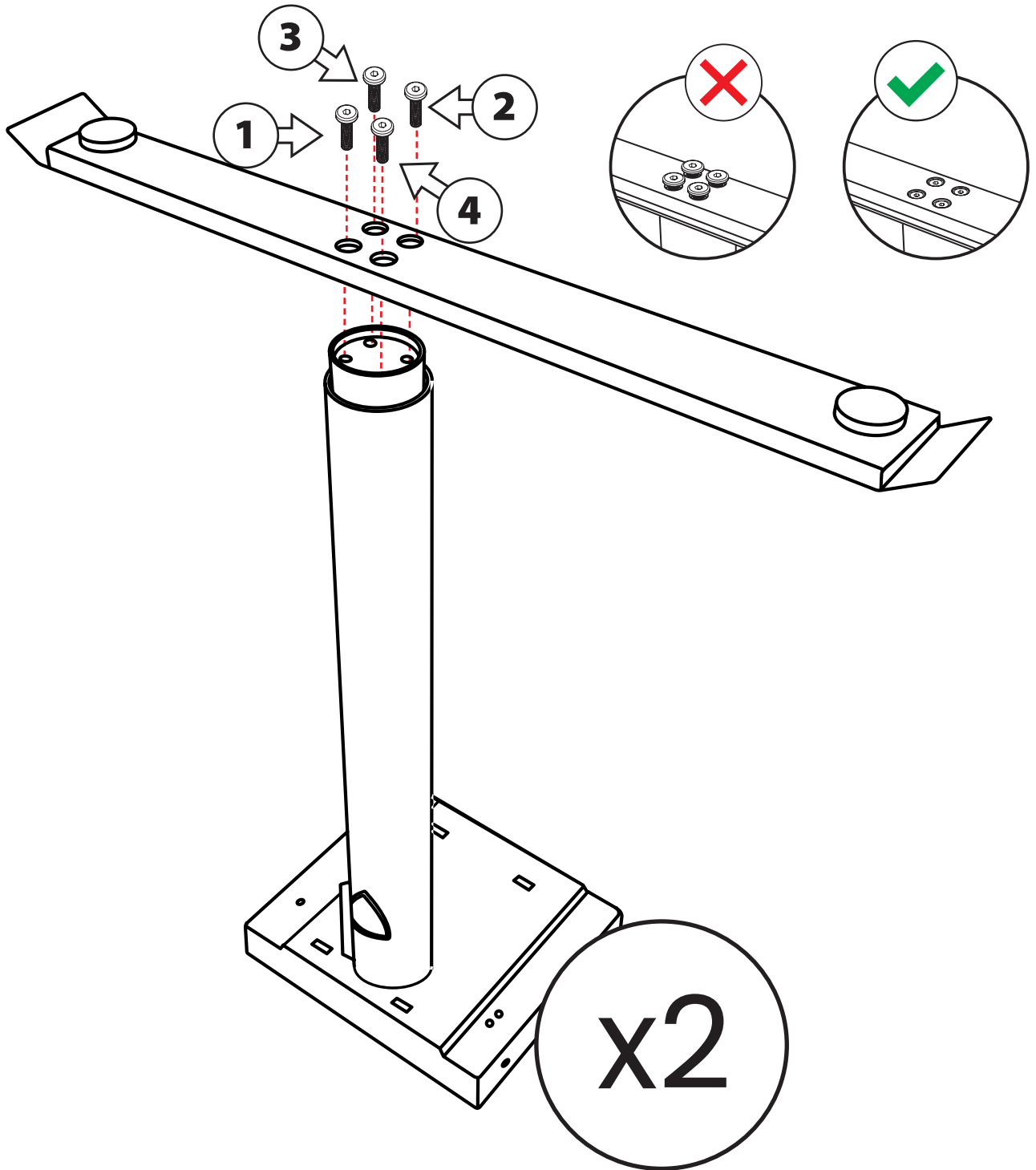
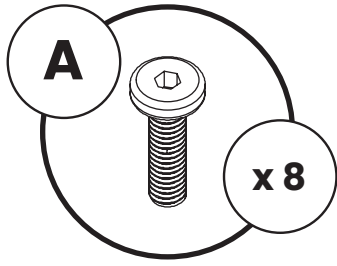

Repeat in order 1 to 4 until all screws are tight

**3**

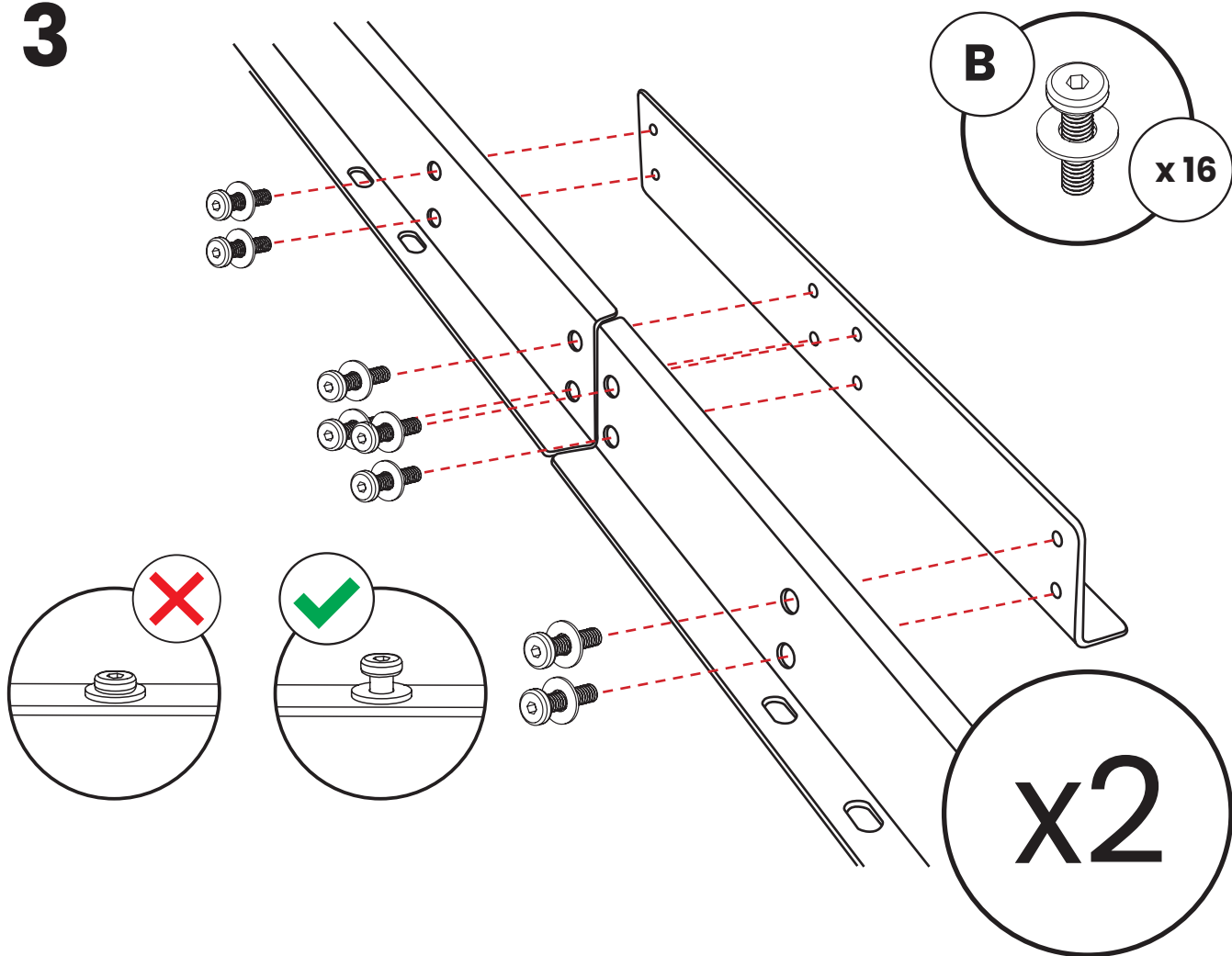

**4**

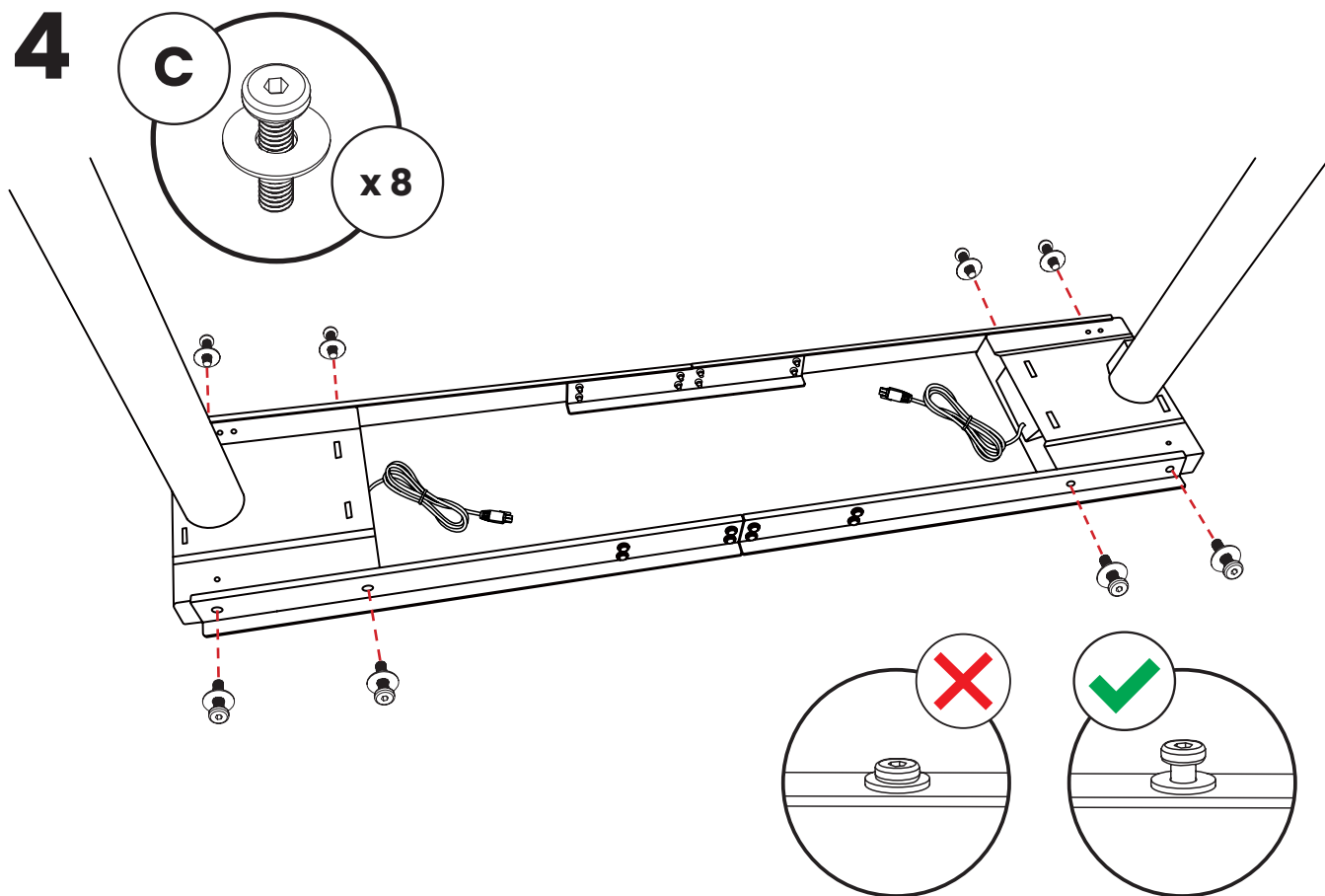

# 5

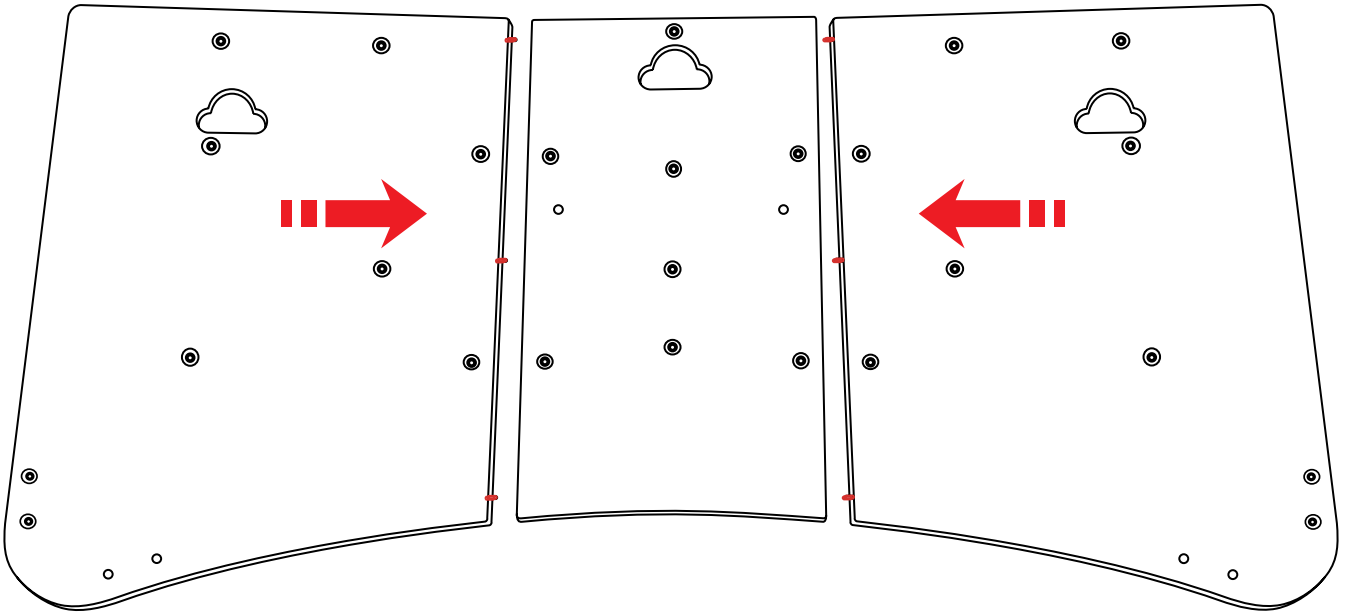

# 6

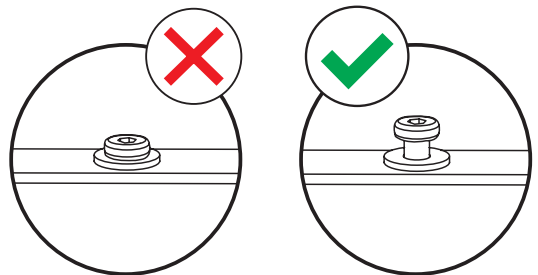
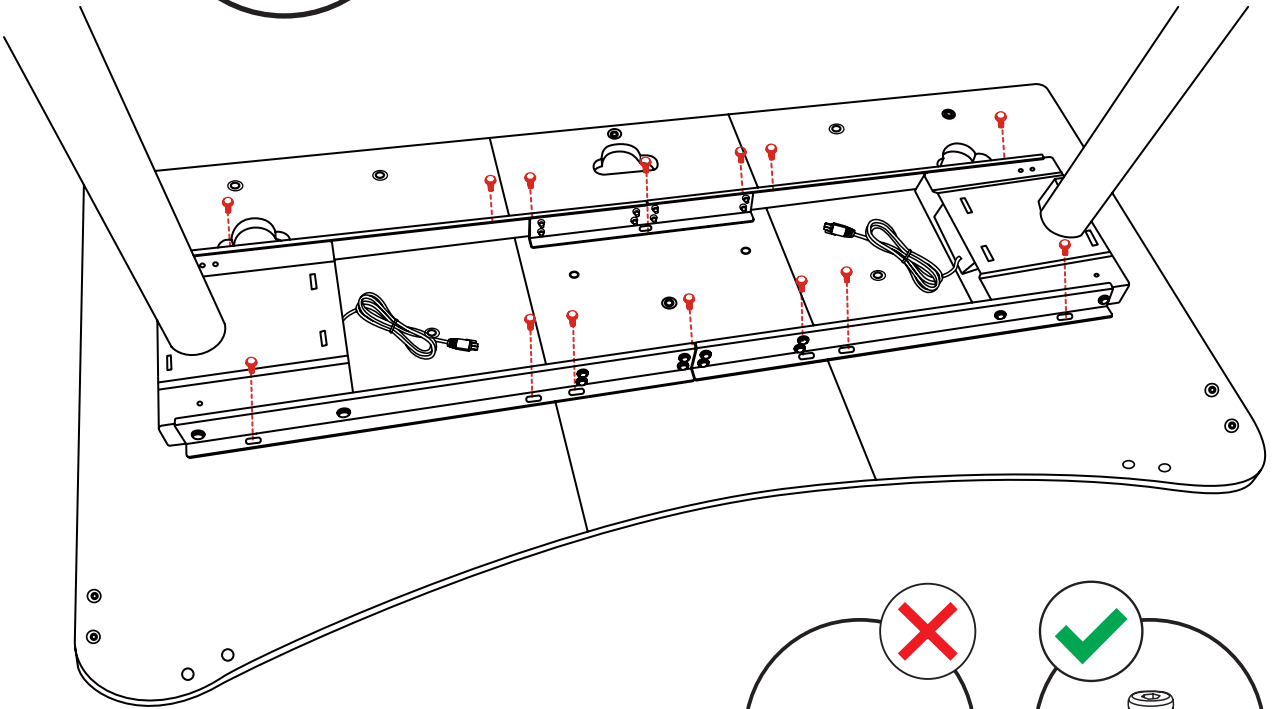
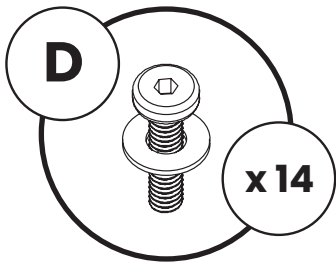



# 7

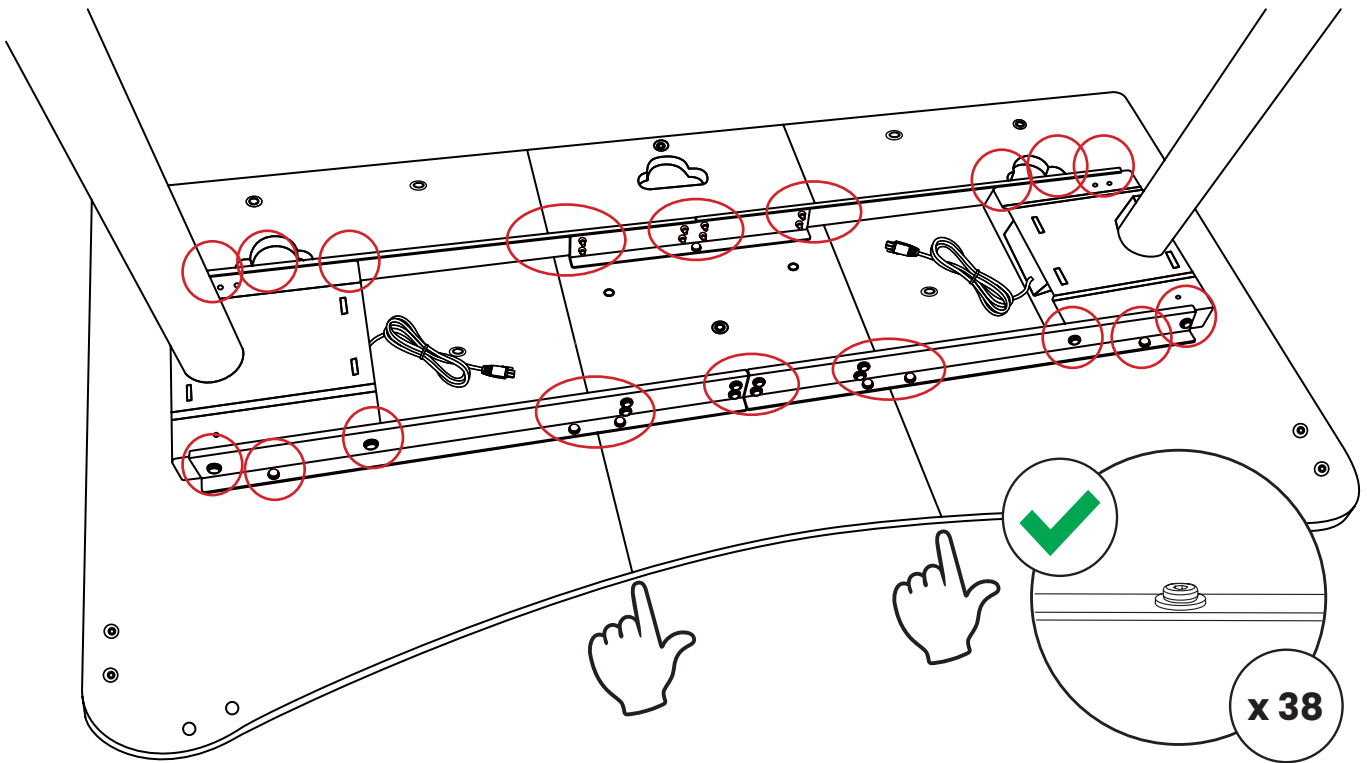

**! Before tightening the screws, make sure that the table top panels are flush against each other.**

# 8

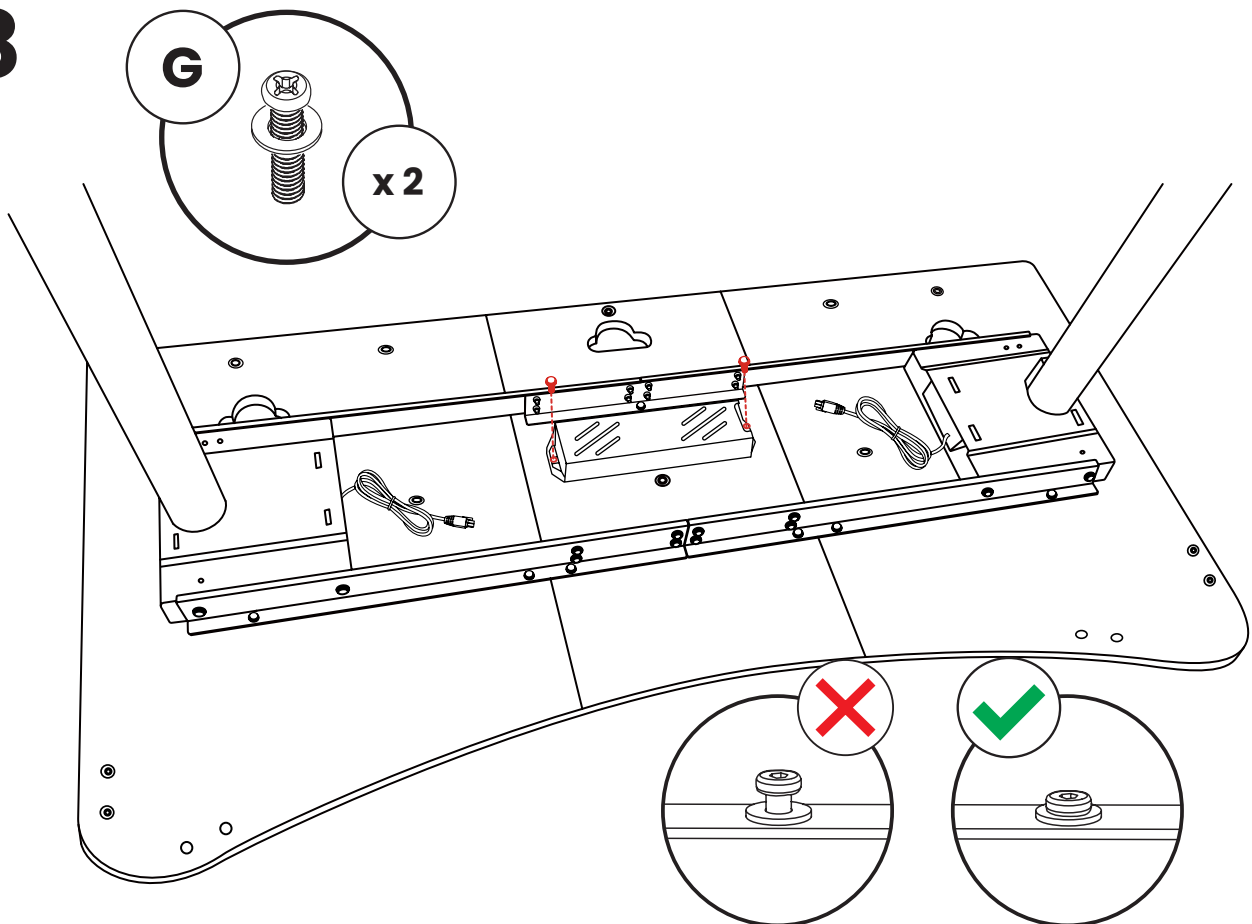

# 9

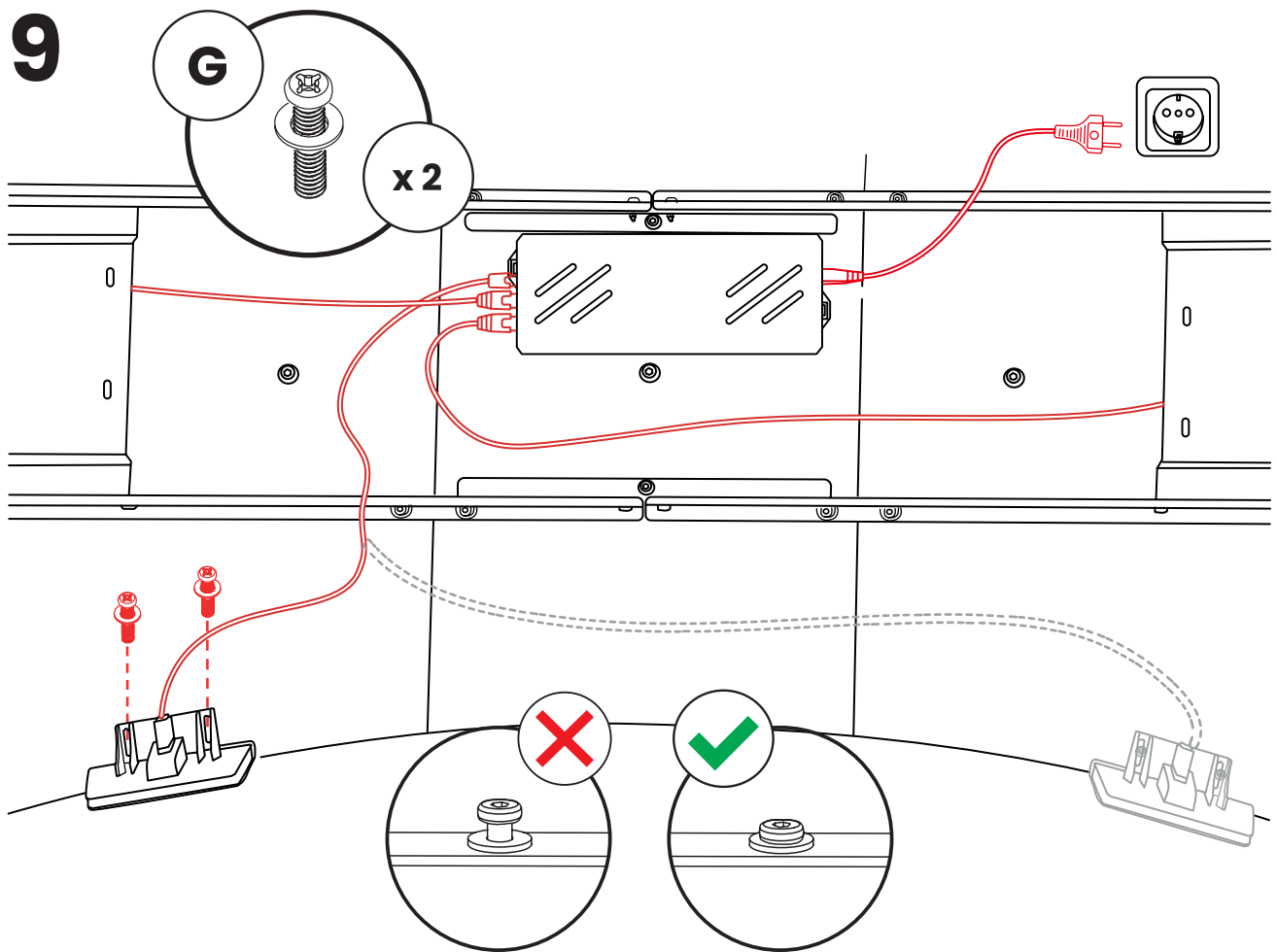

# 10

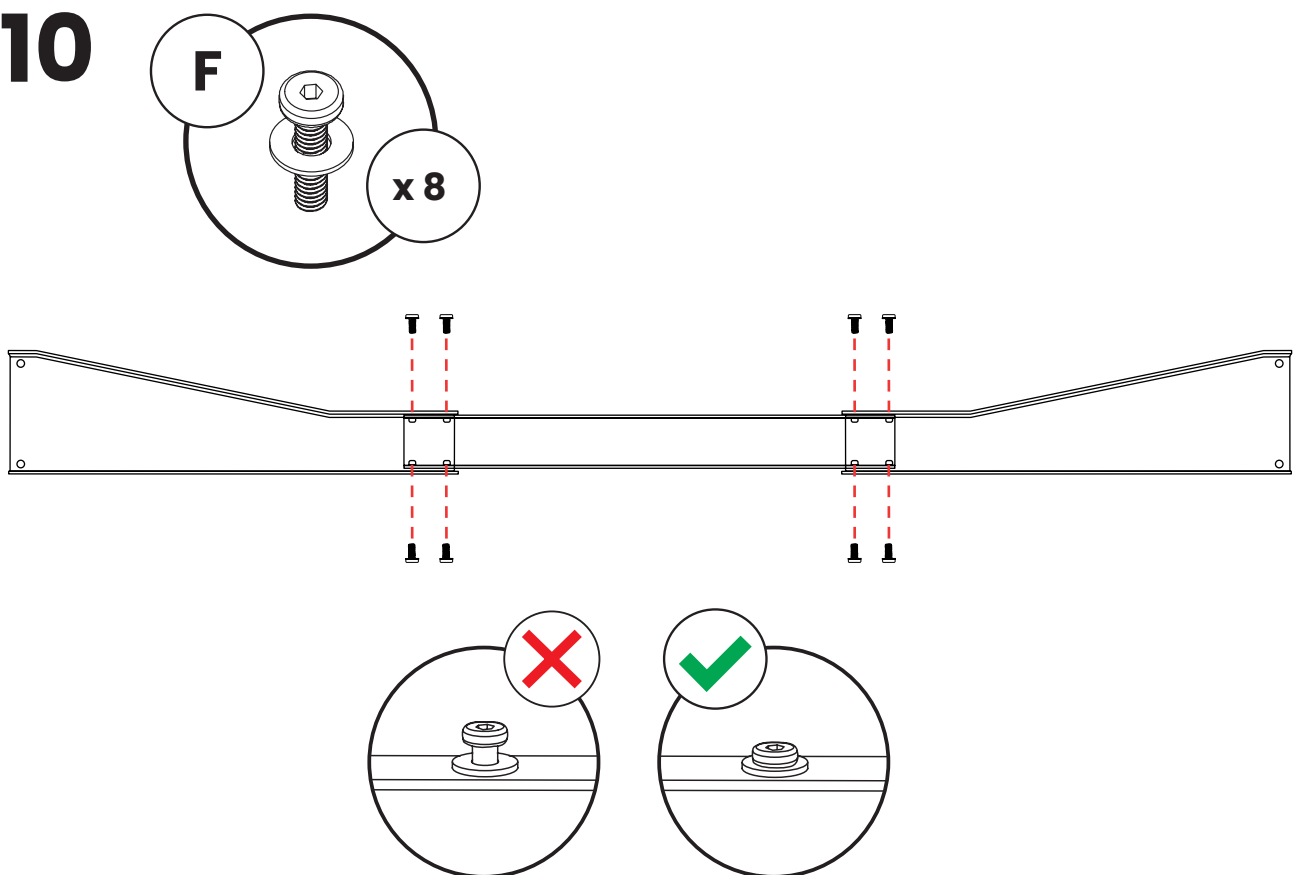

# 11

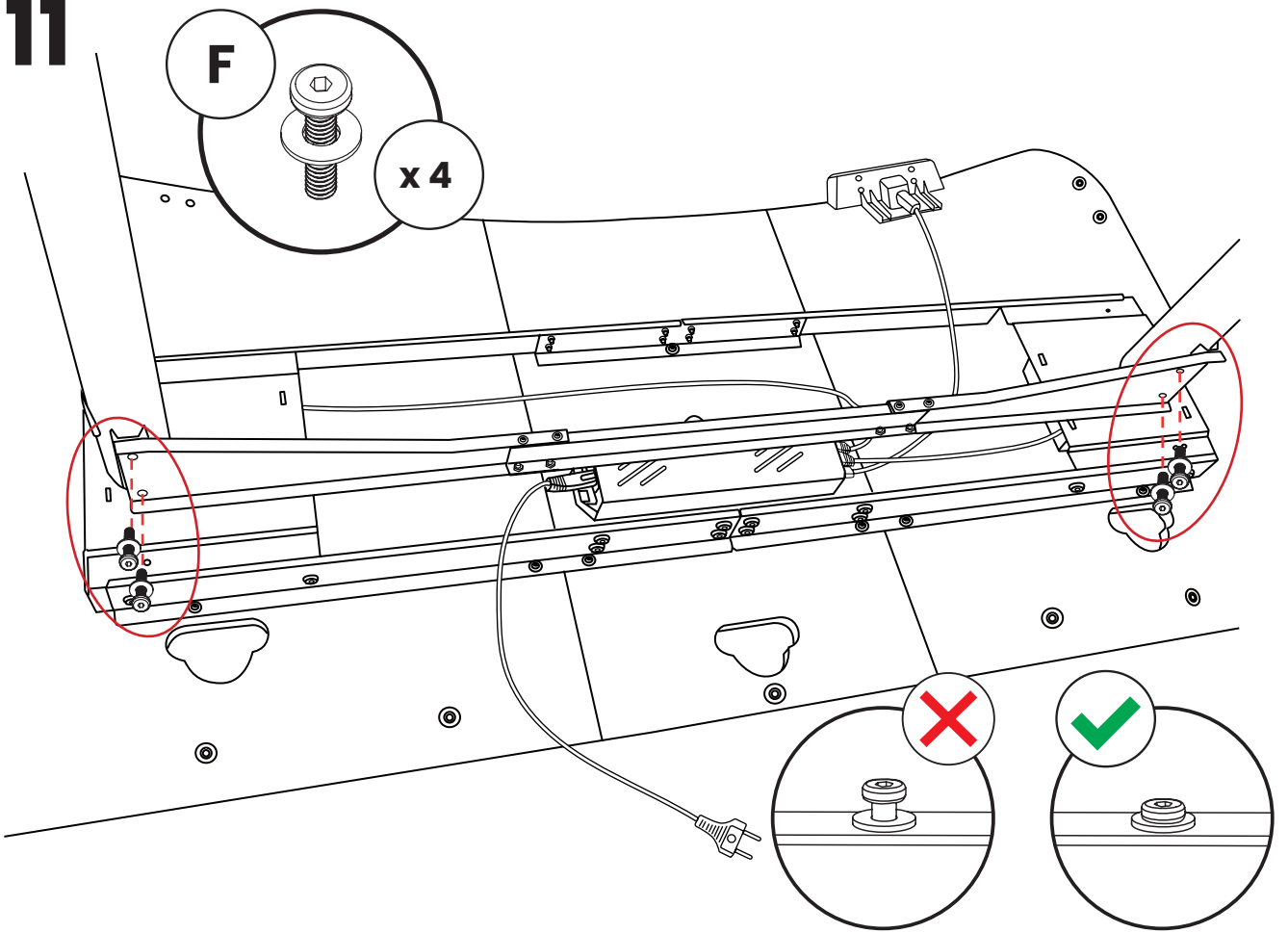

# 12

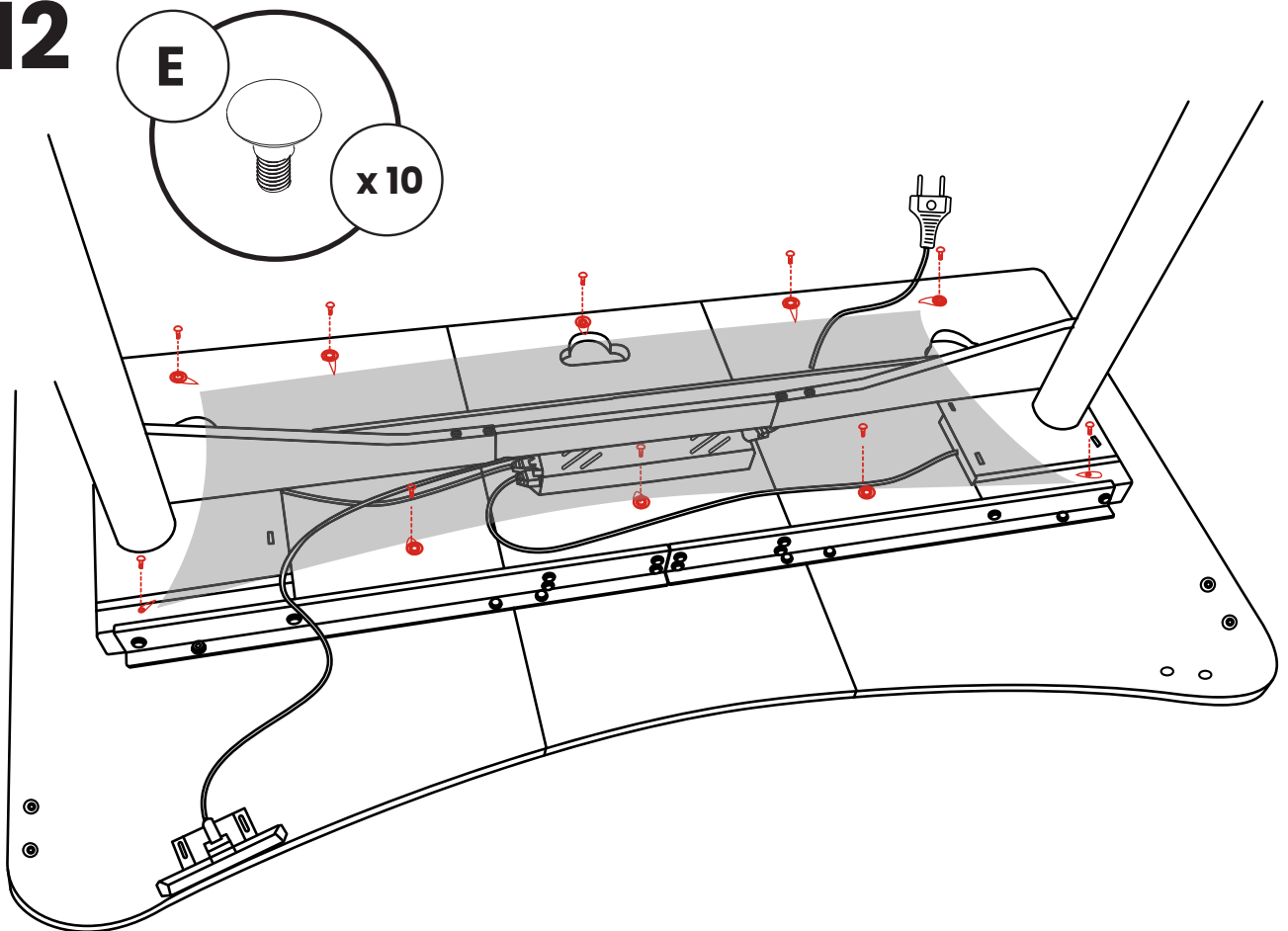

# 13

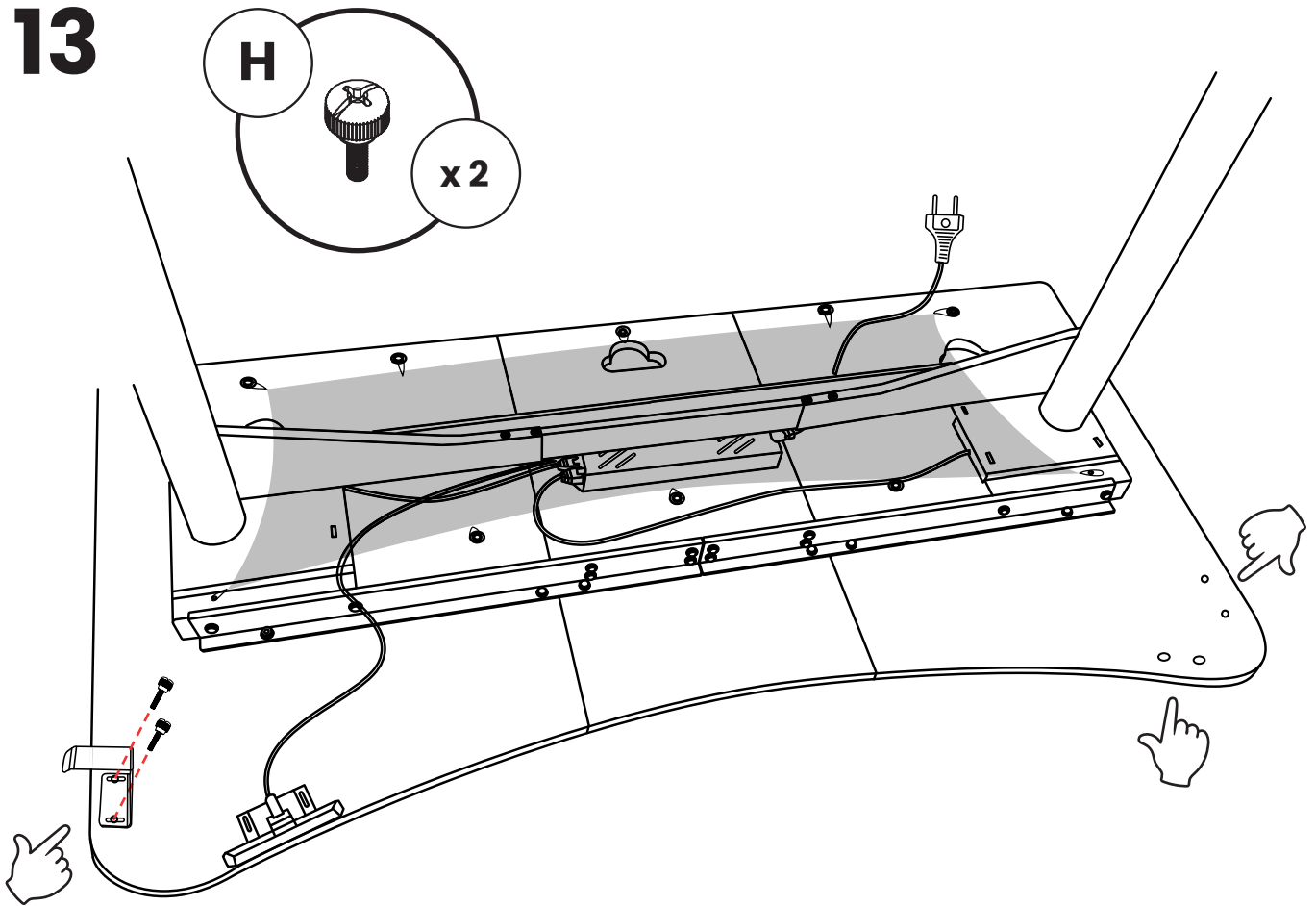

# 14

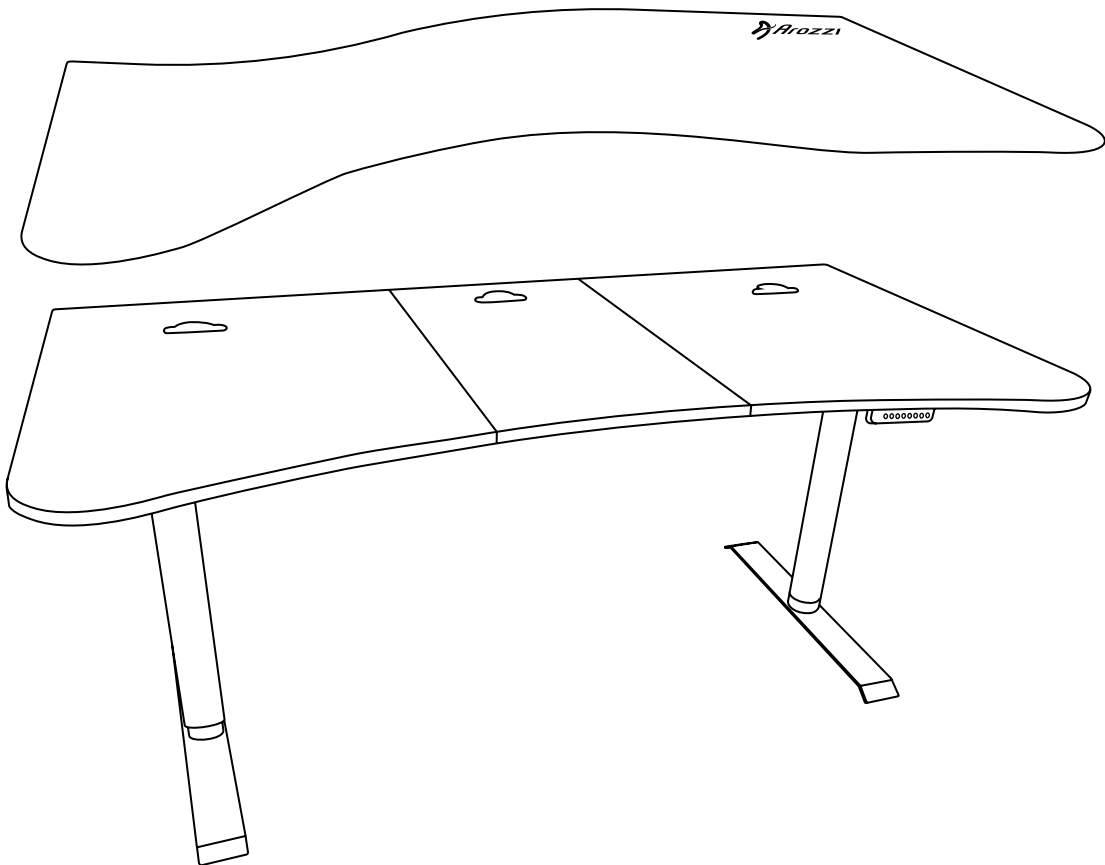

# 15

